

Light for the  
medical workplace



General Catalog  
ENG Version



# Competence in Medical Lighting



## Table of contents

<b>About Derungs Licht AG</b>	04	<b>Accessories</b>	86
• In use worldwide	04		
• Swiss Engineering	06	<b>Arm solutions</b>	92
• Quality as a characteristic	08	• TENO	94
• Our Target Groups	10	• VISO	98
• Product overview	12		
<b>Treatment lights</b>	16	<b>Service</b>	102
• TRIANGO 130 / TRIANGO 130 Duo	18	• Service, Support & Partnership	104
• TRIANGO 100 Duo	22	• Product registration	106
• TRIANGO 100	26		
• TRIANGO 80	30	<b>Light facts</b>	108
• TRIANGO 60	34	• Colour temperature	110
		• Wood's Light	114
<b>Examination lighting</b>	38	<b>Last but not Least</b>	116
• VISIANO 20	40	• Our mission statement	116
• VISIANO 10	44	• Imprint	118
• HALUX N50	48		
• HALUX N30	52		
• HALUX N50/N30 Gynecology	58		
<b>Magnifier luminaires</b>	60		
• OPTICLUX Hand	62		
• OPTICLUX	66		
<b>Bed reading luminaires</b>	70		
• AMALIA	72		
• CULTA LED	76		
<b>Laboratory luminaires</b>	80		
• TANEO Lab	82		

In operation worldwide



## About Derungs Licht AG

We are a medium-sized family business that can look back on more than 80 years of experience in lighting technology. At our location in Gossau (Switzerland) we develop and assemble medical luminaires for physicians all over the world.

Derungs Licht AG is a subsidiary of the international Waldmann Group. Consulting and sales of the luminaires are carried out by the Waldmann-national companies and Derungs partners.



100% heart and soul



## Swiss engineering

Our products have Swiss roots! Together with renowned product designers and users, we develop innovative lights. We are a member of the Swiss Medical Engineering Industry Association.

Quality is our top priority: from the selection of materials to the final assembly, every light passes through our TÜV-certified quality management.

## Typically Derungs

### Special optics

Our proprietary optics ensure a homogeneously illuminated work area without glare.

### Positionally accurate arm systems

Our support arms can be easily aligned and do not drift. This applies to both left- and right-handed users.

### Quality in every detail

When selecting our suppliers, we focus on high quality standards and long-term cooperation.

### Developed for everyday use

Ergonomic comfort, high lighting quality and good cleaning properties provide ideal support in everyday medical life.



# Quality as a feature



## Fatigue-free work

### Light perks up tired eyes

Poor lighting conditions put a strain on our eyes. Headaches, burning eyes and decreased performance can follow. A homogeneous, glare-free light field noticeably relieves strain and promotes performance. A well thought-out lighting concept should therefore include not only the general lighting but also the working area on the patient or in the laboratory.



### Optimal vision

For optimum lighting conditions, light sources with a colour temperature range between 4500 Kelvin and 6500 Kelvin are recommended. Pigment changes, skin disorders or tissue structures can be optimally represented in this colour range.

The Ra index describes how true to life the colours are reproduced under the light source.

The two most important test colours for you as a medical professional are: R9 – red tones and R13 – skin tones. Derungs medical lights have excellent colour rendering properties.

### Best lighting conditions

Illuminance, light colour, and colour rendering are optimized to the daily routine in the clinic. Specially developed optics ensure a homogeneously illuminated work area.

The medical luminaires achieve excellent colour rendering and facilitate diagnosis and treatment. In addition, the illuminance can be dimmed depending on the model.



### Easy cleaning

Due to the crevice-free design of the Derungs medical lights the penetration of liquids and dust is limited. The cleaning of the surfaces is noticeably easier. The handles of the treatment lights TRIANGO 130, TRIANGO 100, TRIANGO 80 and TRIANGO 60 can be removed with one hand and sterilized.

In our instructions for use, you will find information on suitable cleaning agents and care instructions.

# Our target groups



The Derungs portfolio includes products for the medical workplace in clinics, hospitals and laboratories, in human, dental and veterinary medicine.

With so many different options in both light output and functionality, users can find the ideal solution for their application and facility.

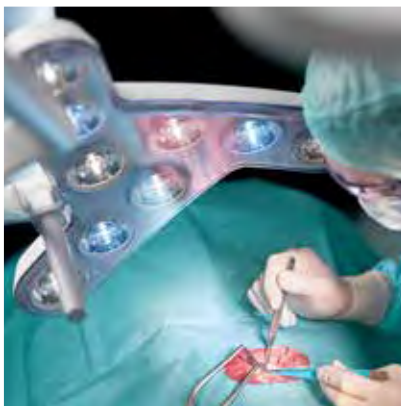

#### Clinics & hospitals

Medical lighting for different departments as well as bedside reading lights and support arm systems



#### Dermatology & plastic surgery

Lighting equipment for surgical and and aesthetic treatments and examinations



#### Dental medicine

Treatment lights for oral and maxillofacial surgery as well as implantology and workplace lighting for dental laboratories



#### Gynecology & urology

Special examination lights connected to examination chairs as well as ceiling mounted treatment lights



#### General medicine

Universal lights for general examinations, minor surgical treatments and practice laboratories



#### Veterinary medicine

Lighting solutions for examinations and minor surgeries as well as special dermatological diagnoses

# Product overview

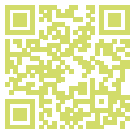

	TRIANGO 150	TRIANGO 100	TRIANGO 80	TRIANGO 60	VISIANO 20	VISIANO 10	HALUX 50	HALUX 30	OPTICLUX Hand	OPTICLUX	AMALIA	CULTA	TANEO
<b>Treatment</b>													
• Minor procedure	●	●	●	○									
• Outpatient procedure	●	●	●	○									
• Endoscopy	●	●	●	○									
• Delivery	●	●	●	○									
• Minor surgery	●	●	●	○									
<b>Surgery preparation</b>													
• Anesthesia	○	○	○	○	○	○	○						
<b>Emergency</b>													
• Trauma room	●	●	●	○	○		○						
<b>Examination</b>													
• General medicine													
• Dermatology	○	○	○	●	●	●	●	○	●	●			
• Neonatology													
• Pediatrics													
<b>Special. examination</b>													
• Gynecology / Obstetrics	●	●	○	○			○	●					
• Urology													
<b>Intensive care</b>				○	○	●	●	○					
<b>Laboratory</b>										●			●
<b>Patient bed</b>							●	●			●	●	
<b>Light intensity</b>	130,000 Lux @ 1.0 m	100,000 Lux @ 1.0 m	80,000 Lux @ 1.0 m	60,000 Lux @ 1.0 m	60,000 Lux @ 0.5 m	50,000 Lux @ 0.5 m	50,000 Lux @ 0.5 m	30,000 Lux @ 0.5 m	8,000 Lux @ 0.15 m	6,000 Lux @ 0.15 m	1,000 Lux @ 0,5 m	1,100 Lux @ 0,5 m	1,400 / 2,000 Lumen

### Fastening

	Ceiling	✓	✓	✓	✓	✓				✓			
	Ceiling Duo Arm system	✓	✓										
	Wall	✓	✓	✓	✓	✓	✓	✓		✓			
	Mobile rolling stand	✓	✓	✓	✓	✓	✓	✓		✓			
	Rolling stand UPSmed pack		✓	✓	✓								
	Pin universal					✓	✓	✓	✓	✓	✓	✓	✓
	Hand lamp								✓				

### Accessories

	Rail mount, wall mount				✓	✓	✓	✓		✓	✓	✓	
	Table clamp, universal fastening				✓	✓	✓	✓		✓	✓	✓	
	Rolling stand				✓	✓	✓	✓		✓			

● ideally suitable ○ well suited

# Product range

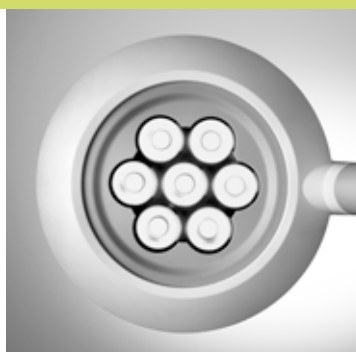

The daily routine can be simplified with the optimal lighting. Derungs medical luminaires combine innovative lighting technology with elegant design.





# Treatment and minor surgical lights



## Light & ergonomics

Thanks to high quality LED technology, colours are optimally reproduced and the work area is illuminated homogeneously and flicker-free. High-quality arm systems with a large radius of movement and exact positioning ensure simple and ergonomic operation.

TRIANGO 130 / TRIANGO 130 Duo



TRIANGO 100 / TRIANGO 100 Duo



TRIANGO 80



TRIANGO 60



[www.derungs.swiss](http://www.derungs.swiss)  
Further variants and technical  
notes can be found here.

# TRIANGO 130



NEW



PREMIUM



## The flagship of treatment lights. TRIANGO 130

The first-class solution for optimal lighting during small procedures and medical treatments. With an impressive 130,000 lux at one metre, the TRIANGO 130 provides maximum light to meet your requirements. This luminaire sets new standards in brightness and precision.



TRIANGO 130	technical data
<b>luminous power *</b>	130,000 Lux / 1.0 m TRIANGO 130 Duo: 2 x 130,000 Lux / 1.0 m
<b>colour temperature *</b>	adjustable: 3700 K / 4300 K / 4700 K
<b>lighting field @ 1.0 m *</b>	focusable: 16 / 20 / 25 cm
<b>depth of illumination *</b>	80 cm
<b>colour rendering index</b>	Ra > 96
<b>usage</b>	touch panel on cardanic system
<b>class of protection</b>	I
<b>protection rating</b>	IP 20 IP 43 (horizontal position)

special features	
<b>TRIANGO Fokus 130-3</b>	<ul style="list-style-type: none"> <li>• 4-step dimmable (100% / 80% / 60% / 40%) *</li> <li>• 3 colour temperatures</li> <li>• focusable</li> </ul>
<b>fastening</b>	<ul style="list-style-type: none"> <li>• ceiling</li> <li>• wall</li> <li>• roller stand</li> </ul>
<b>accessories</b>	<ul style="list-style-type: none"> <li>• sterilizable handle</li> <li>• disposable sterile handle cover</li> </ul>

# TRIANGO 130 – variations



TRIANGO 130 C ceiling version



TRIANGO 130 W wall mount



TRIANGO 130 F roller stand



TRIANGO 130 C Duo ceiling version



**Maximum brightness**

130,000 lux at one metre - this impressive light level ensures optimum visibility and enables maximum precision during procedures and medical treatments. The three-stage focussing function provides additional support. The TRIANGO 130 is a highlight in terms of form and function.

**Cost efficient**

Whether for use in hospitals, private clinics or in veterinary medicine, the TRIANGO 130 entirely fulfils the requirements for the desired brightness and no additional, expensive alternatives are required. The luminaire is easy to clean and offers a long service life.

Product highlights



**Ideal colour temperature**  
optionally in three levels adjustable (3700 K / 4300 K / 4700 K)



**Individually adjustable**  
focusable to 14 / 23 / 25 cm and 4-level dimmable



**Intuitive operation**  
simple and within easy reach via touch panel

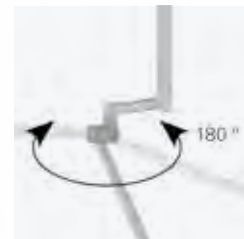

**Unique arm system**  
high positional accuracy and large action radius

# TRIANGO 100 Duo



reddot winner 2020

## The reliable double luminaire system. TRIANGO 100 DUO

Two treatment fields? Low room heights? With the TRIANGO 100 duo ceiling luminaire, the premium treatment light from Derungs, various challenges can be solved.

Two light heads, each with 100,000 lux per meter and excellent lighting technology make it the perfect lighting solution for demanding users.



TRIANGO 100 Duo	technical data
<b>luminous power *</b>	2 x 100,000 Lux / 1.0 m
<b>colour temperature *</b>	fixed: 4300 K adjustable: 3700 K / 4300 K / 4700 K
<b>lighting field @ 1.0 m *</b>	Ø fixed 18 cm   focusable: 18 – 28 cm
<b>depth of illumination *</b>	80 cm
<b>colour rendering index</b>	Ra > 96
<b>usage</b>	touch panel on cardanic system
<b>class of protection</b>	I
<b>protection rating</b>	IP 43 (luminaire head)



special features	
<b>TRIANGO 100-1 C Duo</b>	4-step dimmable (100% / 80% / 60% / 40%) *
<b>TRIANGO Fokus 100-3 C Duo</b>	<ul style="list-style-type: none"> <li>• 4-step dimmable (100% / 80% / 60% / 40%) *</li> <li>• 3 colour temperatures</li> <li>• focusable</li> </ul>
<b>fastening</b>	ceiling

# TRIANGO 100 Duo



### First class light

The specially developed diamond optics relieve the eyes and ensures the best colour homogeneity. Each luminaire head provides 100,000 lux at one meter. Touch pad controls allow the illumination intensity can be adjusted. Optionally the illumination field can be focused or different colour temperatures (3700 K / 4300 K / 4700 K) can be used.

### High mobility

The high-quality support arm system offers perfect mobility: an exceptional radius of action of > 180 cm, joints with 360° rotation and a large angle of movement. The aluminum arm system is especially durable and easy to clean.

## Product highlights



**Duo ceiling light**  
enables interventions on 2 treatment fields.  
Can also be used at low room heights.



Unique Duo arm system



**Parallel bearing arm connection**  
perfect mobility with large radius of action.

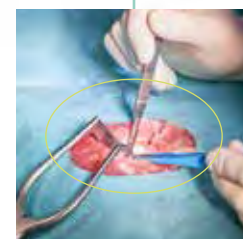

**Homogeneous and low-shadow**  
Illumination field fixed 18 cm, optional focusable 18 - 28 cm.

# TRIANGO 100



## Select equipment. Perfect vision. TRIANGO 100

With its outstanding light output of 100,000 lux at one meter, it is particularly suitable for treatments, surgical interventions or in-depth examinations. Thanks to first-class colour rendering properties and LEDs in two different light colours, it also supports medical professionals in areas such as dermatology, gynecology and urology.



TRIANGO 100	technical data
<b>luminous power *</b>	100,000 Lux @ 1.0 m
<b>colour temperature *</b>	fixed: 4300 K adjustable: 3700 K / 4300 K / 4700 K
<b>lighting field @ 1.0 m *</b>	Ø fixed 18 cm focusable: 18 / 23 / 28 cm
<b>depth of illumination *</b>	80 cm
<b>colour rendering index</b>	Ra > 96
<b>usage</b>	touch panel on cardanic system
<b>class of protection</b>	I
<b>protection rating</b>	IP 43 (luminaire head) IP 20 (UPSmed pack)

special features	
<b>TRIANGO 100-1</b>	4-step dimmable (100% / 80% / 60% / 40%) *
<b>TRIANGO 100-3</b>	<ul style="list-style-type: none"> <li>4-step dimmable (100% / 80% / 60% / 40%) *</li> <li>3 colour temperatures</li> </ul>
<b>TRIANGO Fokus 100-1</b>	<ul style="list-style-type: none"> <li>4-step dimmable (100% / 80% / 60% / 40%) *</li> <li>focusable</li> </ul>
<b>TRIANGO Fokus 100-3</b>	<ul style="list-style-type: none"> <li>4-step dimmable (100% / 80% / 60% / 40%) *</li> <li>focusable</li> <li>3 colour temperatures</li> </ul>
<b>TRIANGO Endo 100-1</b>	<ul style="list-style-type: none"> <li>4-step dimmable (100% / 80% / 60% / 40%) *</li> <li>Endo Mode</li> </ul>
<b>fastening</b>	<ul style="list-style-type: none"> <li>ceiling</li> <li>wall</li> <li>roller stand</li> <li>roller stand UPSmed pack</li> </ul>

# TRIANGO 100 – variations



TRIANGO 100 C ceiling version



TRIANGO 100 W wall mount



TRIANGO 100 F roller stand



TRIANGO 100 F Battery



**Model with endo mode**

When the doctor is performing an endoscopic procedure, the illuminance must be adjusted so that the view of the monitor is not obstructed by glare or reflection.

**Optional: focusable light field**

An adjustable light field gives every physician great flexibility in everyday work. Depending on the size of the treatment area, the light can be optimally adjusted. Especially for treatments on the patient's face, a smaller light field protects the patient from glare. For larger treatment areas, it is not necessary to to realign the luminaire.

Product highlights



**Ideal colour temperature**  
optionally in three levels adjustable (3700 K / 4300 K / 4700 K)\*



**Unique arm system**  
high positional accuracy and large action radius



**Diamond shaped optics**  
for highest light quality



**Intuitive operation**  
simple and within easy reach via touch panel

\* -10% / +20% tolerance

# TRIANGO 80

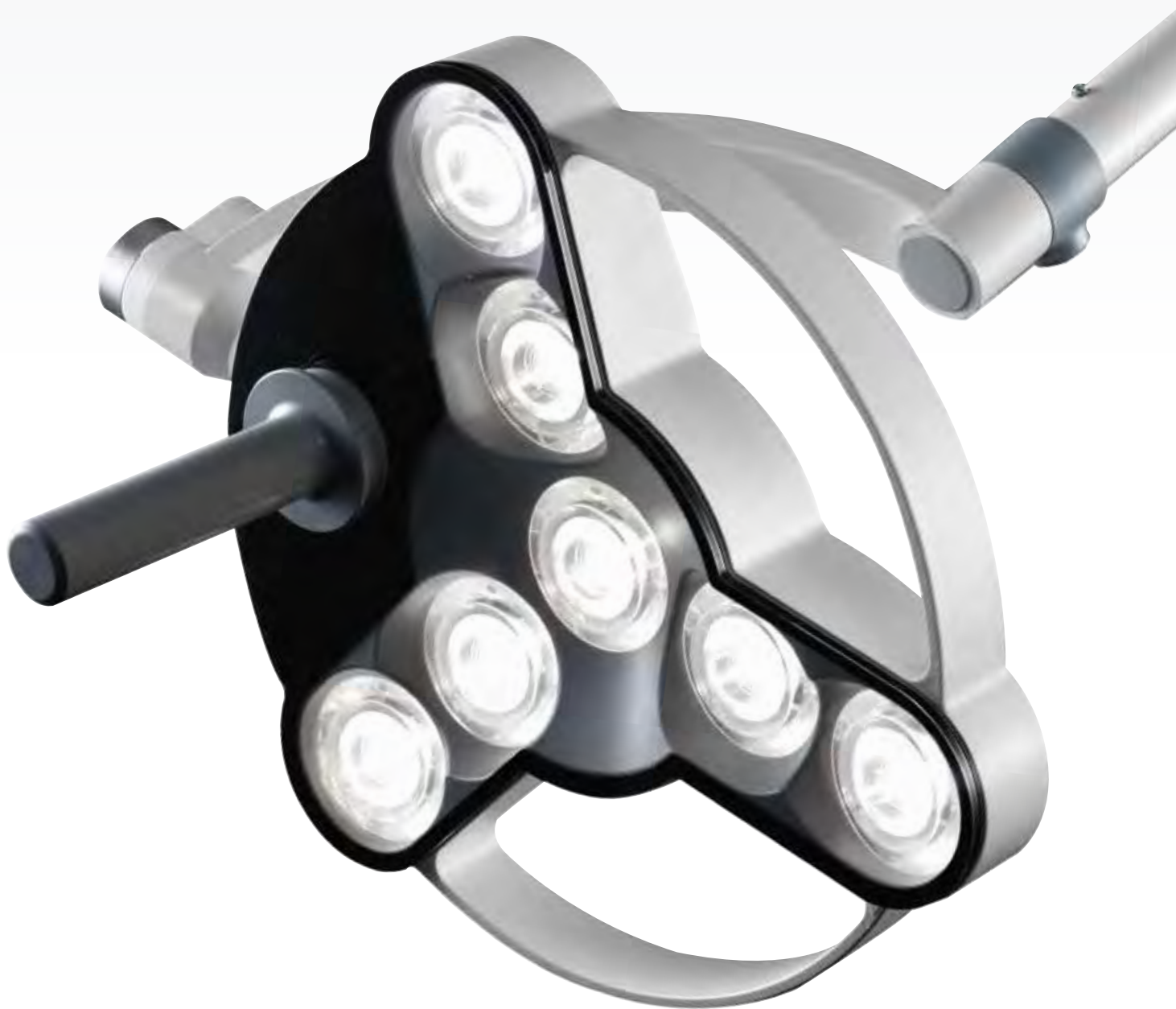

## A proven classic. TRIANGO 80

With 80,000 lux at a distance of one meter and a light field diameter of 18 cm, the medical staff has a powerful treatment light at its disposal.

The illumination field is pleasantly homogeneous and continuously dimmable.

The arm system enables simple and accurate alignment of the lamp head position.

The handle makes it easy for right-handed and left-handed users to position the light.



TRIANGO 80	technical data
luminous power *	80,000 Lux @ 1.0 m
colour temperature *	ca. 4500 K
lighting field @ 1.0 m *	Ø 18 cm
depth of illumination	124 cm
colour rendering index	Ra > 95
usage	rotary switch on the luminaire head
class of protection	I
protection rating	IP 43 (luminaire head) IP 20 (UPSmed pack)

special features	
TRIANGO 80-1	<ul style="list-style-type: none"> <li>continuously dimmable (40-100%) *</li> </ul>
fastening	<ul style="list-style-type: none"> <li>ceiling</li> <li>wall</li> <li>roller stand</li> <li>roller stand UPSmed pack</li> </ul>

# TRIANGO 80 – variations



TRIANGO 80 C ceiling version



TRIANGO 80 W wall mount



TRIANGO 80 F roller stand



TRIANGO 80 F Battery



# TRIANGO 60



## The compact one that has what it takes. TRIANGO 60

Since summer 2023, the TRIANGO 60 will enrich the range of lights for minor procedures and treatments. Its minimalist design is striking. Thanks to an intuitive pushbutton, the illuminance of 60,000 lux at 1m can be continuously adjusted. It is suitable for the versatile daily routine in family practices and clinics as well as in gynecology, dermatology or veterinary medicine.



TRIANGO 60	technical data
<b>luminous power *</b>	60,000 Lux @ 1.0 m
<b>colour temperature *</b>	ca. 4700 K
<b>lighting field @ 1.0 m *</b>	Ø 18 cm
<b>depth of illumination *</b>	140 cm
<b>colour rendering index *</b>	Ra > 95
<b>usage</b>	touch panel on cardanic system
<b>class of protection</b>	I
<b>protection rating</b>	IP 43 (illumination head) IP 20 (UPSmed pack)

Special features	
<b>TRIANGO 60-1</b>	continuously dimmable (15-100%) *
<b>TRIANGO 60-3</b>	<ul style="list-style-type: none"> <li>continuously dimmable (15-100%) *</li> <li>3 colour temperatures</li> </ul>
<b>TRIANGO Fokus 60-1</b>	<ul style="list-style-type: none"> <li>continuously dimmable (15-100%) *</li> <li>focusable</li> </ul>
<b>fastening</b>	<ul style="list-style-type: none"> <li>ceiling</li> <li>wall</li> <li>roller stand</li> <li>roller stand UPSmed pack</li> </ul>

# TRIANGO 60 – variations



TRIANGO 60 C ceiling version



TRIANGO 60 W wall mount



TRIANGO 60 F roller stand



TRIANGO 60 F Battery



### Variable mounting options

Whether mounted on the ceiling, on the wall or on the Derungs roller stand – TRIANGO 60 can be used wherever its homogeneous light field is needed. And in the event of faults in the input power source or mains power, the TRIANGO 60 battery provides an uninterrupted power supply so that it can continue to light up without interference.

### Hygiene made simple

Good design dispenses with unnecessary details and places value on building structures that are as self-contained as possible. The benefit of this is that our TRIANGO 60 can be cleaned very quickly and effectively. A real plus in everyday practice.

## Product highlights

#### Versatile

versions with focusable or colour changeable illumination field

#### Homogeneous light field

unique diamond optic

#### Easy cleaning

streamlined design and the removable handle



#### Ergonomic handling

easy alignment for right- and left-handed

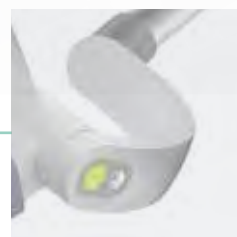

#### Intuitive operation

thanks to touch panel on the cardanic

# Examination lighting

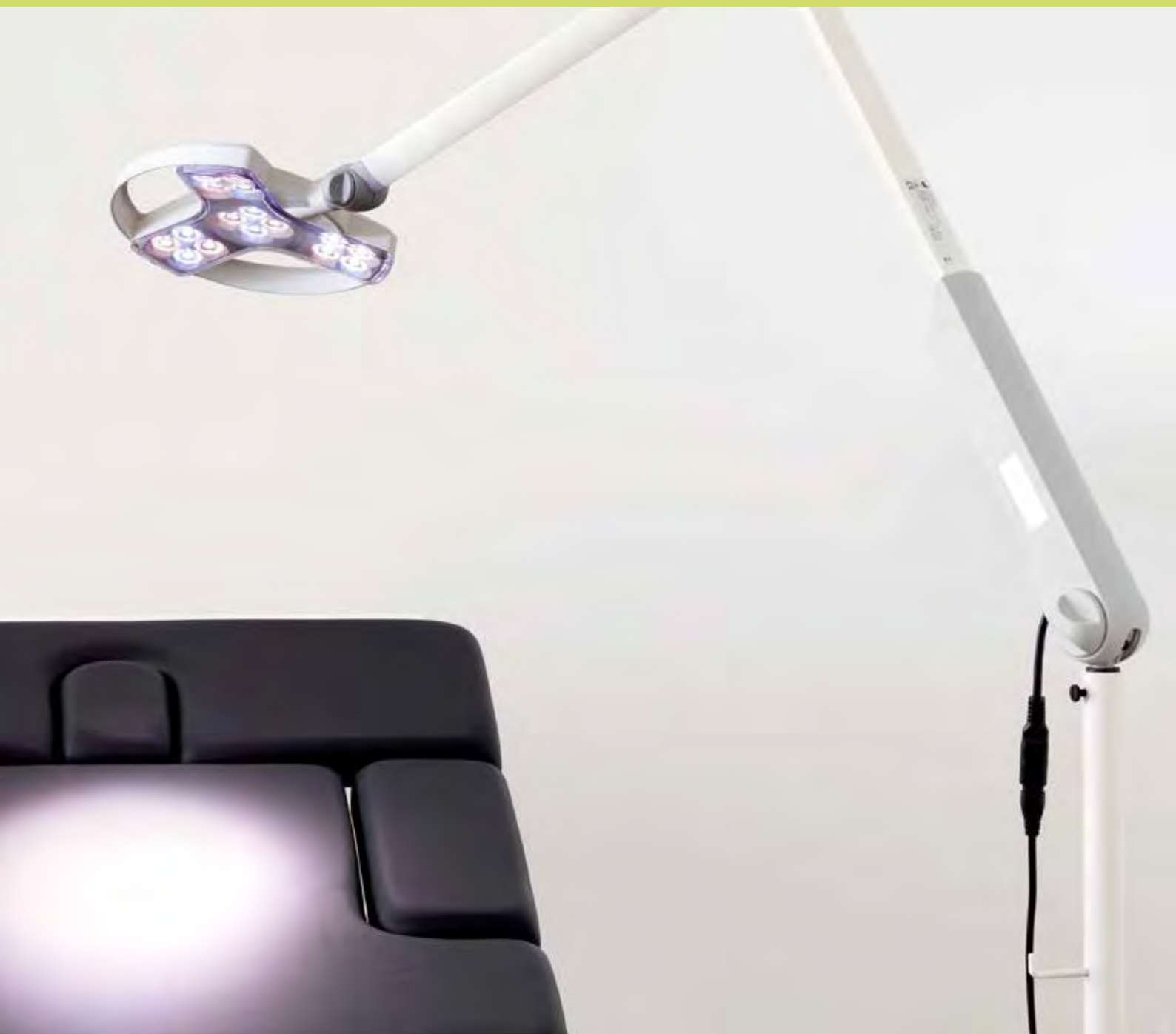

## Design and lighting technology

Versatile examination lights are used for specific illumination of the patient's body. They are coordinated in terms of illuminance, light colour and colour rendering to support diagnosis. The special design of the Derungs medical luminaires blends elegantly into the architecture of clinics and hospitals.

VISIANO 20



VISIANO 10



HALUX N50



HALUX N30



[www.derungs.swiss](http://www.derungs.swiss)  
Further variants and technical  
notes can be found here.

# VISIANO 20



## Outstanding in design and function. VISIANO 20

The VISIANO 20 is the premium product for general examinations.

The light output of 60,000 lux at a distance of 0.5 m is outstanding in this class.

This makes it suitable for versatile applications: general medicine, dermatology, gynecology, urology, neonatology and anesthesia. But also in intensive care, emergency and in the preparation for surgery, it provides excellent illumination and LEDs in two different light colours.



VISIANO 20	technical data
<b>luminous power *</b>	60,000 Lux @ 0.5 m
<b>colour temperature *</b>	3500 K & 4500 K
<b>lighting field @ 1.0 m *</b>	Ø 21 cm
<b>colour rendering index</b>	Ra > 95
<b>usage</b>	touch panel on light head
<b>class of protection</b>	ceiling version: I pin version: II
<b>protection rating</b>	IP 20

special features	
<b>VISIANO 20-2</b>	<ul style="list-style-type: none"> <li>• 2 colour temperatures</li> <li>• dimmable</li> </ul>
<b>fastening</b>	<ul style="list-style-type: none"> <li>• ceiling</li> <li>• pin universal</li> </ul>
<b>accessories</b>	<ul style="list-style-type: none"> <li>• wall mount</li> <li>• roller stand</li> <li>• fastening hardware</li> <li>• universal mount</li> <li>• table clamp</li> </ul>

# VISIANO 20 – variations



VISIANO 20 C ceiling version



VISIANO 20 P pin version



**Versatile use**

The mounting options leave nothing to be desired:  
The VISIANO Pin version can be combined with versatile accessories e.g. roller stand, rail mount, wall mount.  
The ceiling version rounds off the mounting options.

**High quality lighting technology**

VISIANO 20 is equipped with LEDs in two colour temperatures as standard. The special optics provide a glare-free and homogeneous illumination field.  
High-quality materials and long-life LEDs ensure a flawless use.

**Product highlights**



**Colour change**  
for optimal contrast vision



**Unique diamond optic**  
for best colour homogeneity of the light



**360° turnover axis**  
for maximum light availability



**Spring-relieved friction joint**  
for secure hold



# VISIANO 10



## Reduced to the essentials. VISIANO 10

The VISIANO 10 is an examination light that is reduced to the essentials, but still delivers professional lighting technology. The illuminance, with 50,000 lux at a distance of 0.5 m, is suitable for general examinations but also for intensive care and neonatology. The ergonomic handle makes it easy to align the light field.



VISIANO 10	technical data
luminous power *	50,000 Lux @ 0.5 m
colour temperature *	4400 K
lighting field @ 1.0 m *	Ø 18 cm
colour rendering index	Ra > 93
usage	rocker switch (I/O) on arm
class of protection	II
protection rating	IP 20

Special features	
VISIANO 10-1 P S10	<ul style="list-style-type: none"> <li>• handle</li> <li>• luminaire head can be swivelled 280°</li> </ul>
fastening	<ul style="list-style-type: none"> <li>• pin universal</li> </ul>
accessories	<ul style="list-style-type: none"> <li>• wall mount</li> <li>• roller stand</li> <li>• fastening hardware</li> <li>• universal mount</li> <li>• table clamp</li> </ul>

# VISIANO 10 – variations



## VISIANO 10 P

pin version | with accessory roller stand

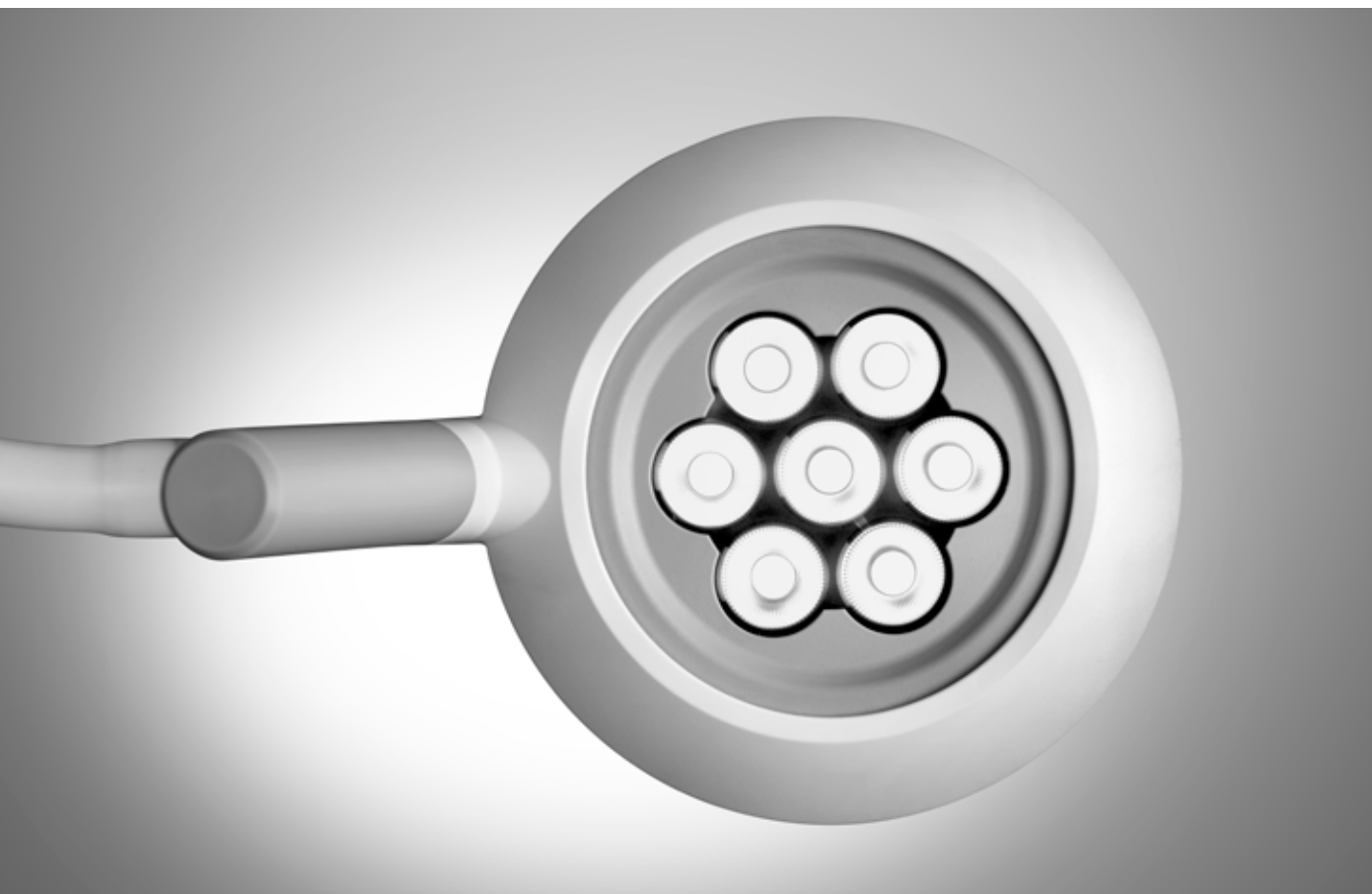

**Various connections**

The VISIANO 10 can be combined with Derungs accessories. Depending on the requirements, it can be fixed directly to the wall with a wall mount or a rail mount. The Derungs roller stand is suitable for mobile use.

**Easy cleaning**

Thanks to its closed and minimalistic design, the VISIANO 10 can be cleaned in a time-saving manner. Dust and liquids cannot enter the interior. This means that nothing stands in the way of long-lasting use.

Product highlights



**Economical**  
due to low energy consumption and high-quality components

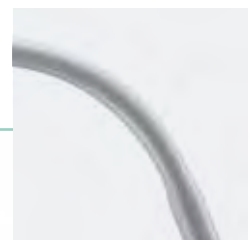

**Durable flex arm**  
for safe positioning and durable use



**Large radius of action**  
thanks to 280° rotatable lamp head and special arm

# HALUX N50



## Versatile classic. HALUX N50

HALUX N50 is the right luminaire for anyone looking for good lighting quality. The illuminance of up to 50,000 lux at 0.5 m and the 18 cm large light field provide optimal examination conditions. It is versatile for examinations in dermatology, intensive care, neonatology, gynecology, obstetrics or urology, but also at the patient's bedside or for the preparation of a surgical procedure.



HALUX N50	technical data
<b>luminous power *</b>	50,000 Lux @ 0.5 m
<b>colour temperature *</b>	fixed: 4400 K adjustable: 3300 K / 3800 K / 4400 K **
<b>lighting field @ 0.5 m *</b>	Ø 18 cm
<b>colour rendering index</b>	Ra > 93
<b>usage</b>	touch panel on luminaire head or rocker switch (I/O)
<b>class of protection</b>	II
<b>protection rating</b>	IP 20 (luminaire head)

special features	
<b>HALUX N50</b>	<ul style="list-style-type: none"> <li>• 3 colour temperatures **</li> <li>• 5-stage dimmable **</li> <li>• maintenance-free</li> </ul>
<b>variations</b>	gynecology
<b>fastening</b>	pin universal
<b>accessories</b>	<ul style="list-style-type: none"> <li>• wall mount</li> <li>• roller stand</li> <li>• fastening hardware</li> <li>• universal mount</li> <li>• table clamp</li> </ul>

# HALUX N50 – variations



HALUX N50 P FX

pin version | spring arm



HALUX N50 P SX

pin version | flexarm



**Large assortment**

HALUX N50 impresses with a well thought out variety: with a robust flexible arm or a positionally stable spring arm, LEDs with defined or adjustable colour temperatures and various mounting options. A special version for connection to the examination chair in gynecology and proctology is also available.

**Durable use**

High-quality materials and long-life LEDs ensure a flawless use. The closed design facilitates cleaning and prevents the penetration of cleaning agents into the luminaire head.

Product highlights



**Intuitive operation**  
simple and within easy reach via touch panel



**Individual light intensity**  
thanks to 5-stage dimming the light is easily adjustable



**Perfect colour rendering**  
optimum light colour for precise and accurate diagnoses



**Optimal contrast vision**  
optional: 3 colour levels for detail fidelity as well as perfect contrasts

3300 K | 3800 K | 4400 K

# HALUX N30



## Small but mighty! HALUX N30

The HALUX N30 is a solid examination fixture with uncompromisingly good light and a very attractive price. The illumination field has a diameter of 18 cm and an illuminance of up to 30,000 lux at 0.5 m which makes it perfectly equipped for the versatile daily routine in the clinic. The good colour rendering properties and the stepless dimming function offer high functionality.



HALUX N30	technical data
luminous power *	30,000 Lux @ 0.5 m
colour temperature *	4400 K
lighting field @ 1.0 m *	Ø 18 cm
colour rendering index	Ra > 93
usage	touch panel on luminaire head
class of protection	II
protection rating	IP 20

special features	
HALUX N30	<ul style="list-style-type: none"> <li>continuously dimmable</li> <li>maintenance-free</li> <li>spring arm</li> </ul>
variations	<ul style="list-style-type: none"> <li>gynecology</li> <li>ambulance</li> </ul>
fastening	<ul style="list-style-type: none"> <li>pin universal</li> <li>roller stand</li> </ul>
accessories	<ul style="list-style-type: none"> <li>wall mount</li> <li>roller stand</li> <li>fasting hardware</li> <li>universal mount</li> <li>table clamp</li> </ul>

# HALUX N30 – variations



**Variety of versions**

The HALUX N30 is available in different versions. Depending on your requirements, it can be mounted directly on the wall or fixed to a rail mount with a rail clamp. The ambulance version can be mounted on C-rails. The gynecology version is suitable for connection to the gynecology chair.

**Conceivably simple**

The 18 cm large illumination field can be easily controlled via the touch panel on the luminaire head. The illuminance can be dimmed steplessly to adapt to the lighting requirements. Cleaning is also simple. This is ensured by the seamless design.

**HALUX N30 P SGH and SGV**

pin version | flex arm with foot joint

**HALUX N30 P SH and SV**

pin version | flex arm



# HALUX N30 – variations



### HALUX N30 P F1

pin version | spring arm with foot joint



### HALUX N30 P Amb

pin version | head joint | ambulance

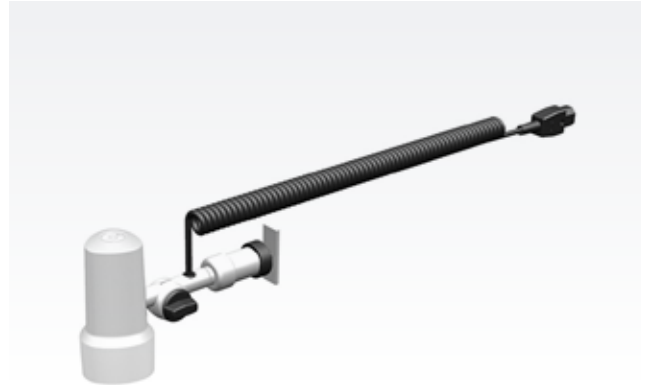

### HALUX N30 F

integrated roller stand



# HALUX N50 and N30 – gynecology



## Lighting solutions for gynecology & urology

We support gynecological and urological clinics as well as proctologists with optimal light. Very good colour rendering properties with Ra values > 93 ensure a natural representation of visible pathologies, tissue and vessels. Unobtrusive spotlights on the examination chair provide ideal light for patient examination.

### HALUX N50-3 P SX Gyn

pin version | flex arm | gynecology

- 50,000 Lux @ 0.5 m
- optional: 5-stage dimmable
- adjustable colour temperature (3300/ 3800/ 4400 K)



#### Securely fastened

rail clamp with brake function

### HALUX N30-1 P SGV Gyn

pin version | flex arm | gynecology

- 30,000 Lux @ 0.5m
- continuously dimmable illumination field with head connection vertical/horizontal
- colour temperature fixed 4400 K



#### Optimal vision

thanks to homogeneous, spot-like illumination field

# Magnifier lumineuses



## Details make the difference.

Magnifier luminaires from Derungs provide valuable support in many areas. They are suitable for dermatologists, dental technicians, laboratories, central steril supply department (CSSD), veterinarians as well as medical clinics and hospitals. OPTICLUX magnifier lamps offer a perfect symbiosis of outstanding light, a large field of vision and a distortion-free representation of the object. This relieves the eyes and makes visual tasks easier.

OPTICLUX Hand



OPTICLUX 10



[www.derungs.swiss](http://www.derungs.swiss)  
Further variants and technical  
notes can be found here.

# OPTICLUX Hand



## Strikingly different. OPTICLUX Hand

The OPTICLUX Hand magnifier luminaire with ergonomic handle provides support for demanding visual tasks. This is ensured by the large dimmable light field in daylight quality, excellent colour rendering properties and long battery life. Dermatologists and veterinarians can look forward to the powerful Wood's Light, which is available as an option in combination with the daylight mode.



OPTICLUX Hand	technical data
<b>luminous power *</b>	8,000 Lux @ 0.15 m
<b>colour temperature *</b>	<ul style="list-style-type: none"> <li>• 6500 K</li> <li>• optional: 365 nm (Wood's Light)</li> </ul>
<b>lens dimension</b>	Ø 16 cm
<b>colour rendering index</b>	Ra > 95
<b>usage</b>	touch panel on handle
<b>battery runtime</b>	up to 3h
<b>class of protection</b>	II
<b>protection rating</b>	IP 20

special features	
<ul style="list-style-type: none"> <li>• dimmable</li> <li>• rechargeable battery with USB-C charging interface</li> <li>• Wood's Light mode (optional)</li> <li>• lens cover</li> <li>• 1.9x magnification</li> </ul>	
<b>OPTICLUX Hand</b>	
<b>variations</b>	battery operated handheld version

# OPTICLUX Hand – variations



## OPTICLUX Hand

Daylight & Wood's Light



## OPTICLUX Hand + Table charger

Setprice available



**First class light**

The OPTICLUX hand magnifier light delivers unique light output of 8,000 lux at a distance of 15 cm. Excellent colour rendering properties > Ra 95 ensure ideal vision.

**Large field of view**

The scratch-resistant plastic lens with 160 mm diameter and 3.5 diopters is ideal for full-body examinations and for assessing dermatological diseases on patients.

Product highlights



**Optional with Wood's Light**  
two lighting modes in one device:  
optional Wood's Light for examination of fungal or bacterial infection on the skin or scalp and pigmentary changes

For detailed description of Wood's Light see page 114.



**Ergonomic**  
optimal handling for right- and left-handed



**Table charging station**  
for storage and charging, white powder-coated with a sturdy aluminium base

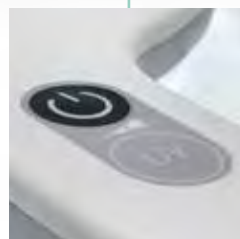

**Easy to operate**  
touch panel on the handle with comfortable, stepless dimming



**Battery operated**  
up to 3 hours battery runtime, flexible charging through USB-C interface

# OPTICLUX 10



**iNOVO<sup>®</sup>**  
AWARDS  
**2017**

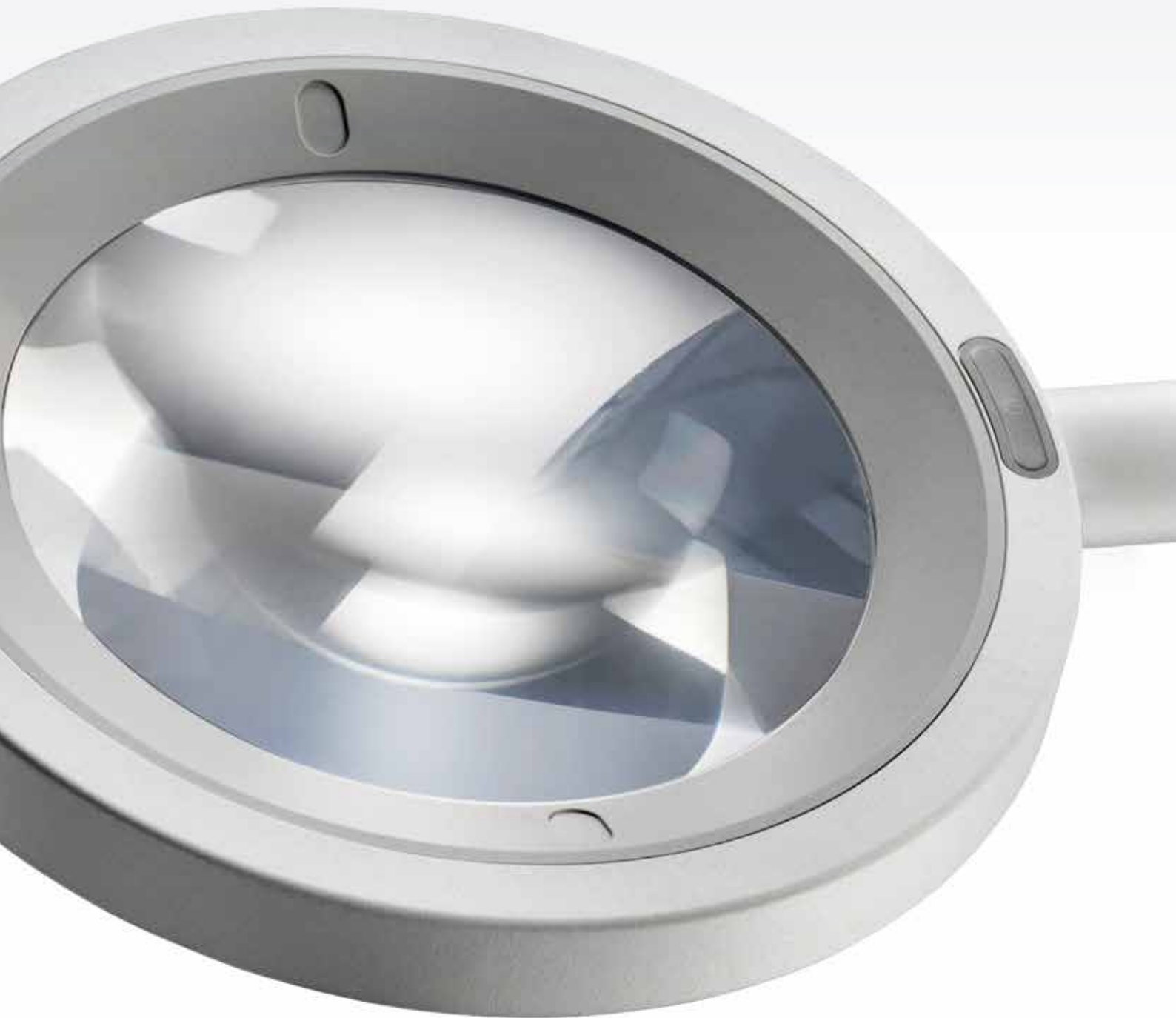

## Details shown in the best light. OPTICLUX 10

The OPTICLUX 10 magnifier light combines a robust magnifier with outstanding light quality and ergonomic operation. As a certified medical product, it is used in dermatology, in clinics and hospitals for human, dental and veterinary medicine, in laboratories and veterinary medicine, in laboratories, but also for central steril supply department (CSSD).



OPTICLUX 10	technical data
<b>luminous power *</b>	6,000 Lux @ 0.15 m
<b>colour temperature *</b>	<ul style="list-style-type: none"> <li>• 6500 K</li> <li>• optional: 365 nm (Wood's Light)</li> </ul>
<b>lens dimension</b>	Ø 16 cm
<b>colour rendering index</b>	Ra > 95
<b>usage</b>	membrane switch on light head
<b>class of protection</b>	<ul style="list-style-type: none"> <li>• version with cover: I</li> <li>• version with pin: II</li> </ul>
<b>protection rating</b>	IP 20

special features	
<b>OPTICLUX 10</b>	<ul style="list-style-type: none"> <li>• dimmable</li> <li>• maintenance-free</li> <li>• Wood's Light mode (optional)</li> <li>• lens cover</li> <li>• 1.9x magnification</li> </ul>
<b>variations</b>	Further connector variants are available on request. <ul style="list-style-type: none"> <li>• table clamp</li> <li>• universal mount</li> </ul>
<b>accessories</b>	<ul style="list-style-type: none"> <li>• fastening hardware</li> <li>• wall mount</li> <li>• roller stand</li> </ul>

# OPTICLUX 10 – variations



OPTICLUX 10 C  
ceiling version



OPTICLUX 10 P  
pin version



## Product highlights



**Optimally protected**  
sturdy plastic cover  
protects the lens from  
scratches and sunlight



**360° turnover axis**  
for maximum light  
availability



**Especially for dermatology**  
two illumination modes in  
one device:  
optional Wood's Light for  
examination of  
fluorescent fungal or  
bacterial infection on the  
skin or scalp and  
pigmentary changes.

**Detailed description**  
to Wood's Light on page 114.

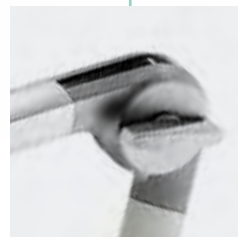

**Ergonomic handling**  
spring arm and internal  
friction joints allow  
comfortable handling  
without any risk of the  
light head drifting



**Flexible positioning**  
long lamp arm makes a  
large radius of action up  
to 142 cm possible

# Bedside reading lights



## Pleasant and glare-free vision

Derungs bed reading lights are characterized by a pleasant lighting effect, good cleaning properties and high functionality. They are universally applicable on standard rails or bed motor controls. Further mounting accessories and model variants round off the possibilities.

### AMALIA



### CULTA LED



[www.derungs.swiss](http://www.derungs.swiss)  
Further variants and technical  
notes can be found here.

# AMALIA



## Reading and orientation. AMALIA

The reading lamp AMALIA offers a pleasing aesthetic design and functionality. The homogeneous reading light increases the reading comfort at the patient's bedside or in the resident's room. An additional night light facilitates orientation. High-quality materials and excellent workmanship reduce maintenance costs and increase cost-effectiveness.

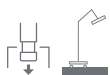

AMALIA	technical data
luminous power *	1,000 Lux @ 0.5 m
colour temperature *	3000 K
lighting field @ 0.5 m *	Ø 45 cm
colour rendering index	Ra > 95, R9 > 90
usage	switch on the handle
class of protection	II
protection rating	IP 20



special features	
AMALIA	<ul style="list-style-type: none"> <li>• Turnover axis (360° turnover axis)</li> <li>• night light (LED)</li> <li>• with removal protection</li> <li>• lampshade: white</li> <li>• luminaire decor: foil / rattan</li> </ul>
fastening	<ul style="list-style-type: none"> <li>• pin universal</li> <li>• floor lamp</li> </ul>
accessories	<ul style="list-style-type: none"> <li>• wall mount</li> <li>• roller stand</li> <li>• fastening hardware</li> <li>• universal mount</li> <li>• table clamp</li> </ul>

# AMALIA – variations



AMALIA 9 P S4

pin version | spring arm ankle joint



AMALIA 9 PS 4 CLINIC

pure white bed reading light



AMALIA 9 P S7

reading light



AMALIA 9 B S8

bed reading light



AMALIA 9 F S3

floor lamp



**Versatile application**

Thanks to Derungs accessories, AMALIA Reading lights can be easily attached to a wall, rail, table or bed. A special CLINIC version for hospitals and clinics in pure white expands the range.

**Durable use**

High-quality materials, efficient light sources and and the high quality of workmanship contribute to the efficiency. AMALIA offers user-friendly handling. The closed construction and smooth surface guarantee quick and hygienic cleaning.

Product highlights



**LED lighting technology**  
with 1,000 Lux @ 0.5 m  
AMALIA offers pleasant  
lighting conditions  
with very good colour  
rendering



**Soothing**  
easy to switch the night  
light on and off with the  
button on the head for  
maximum light availability



**Mobile**  
thanks to 360° turnover  
axis and movable  
arm, the light can be  
individually adjusted



**Robust handle**  
switch on and off  
via button on  
handle



**Decorative**  
Additional lampshade decors for an even  
homelier ambience

# CULTA LED



## Small luminaire. Big personality. CULTA LED

The bedside reading lamp CULTA LED is characterized by its minimalist appearance and its solid construction. The cord switch makes it particularly easy to use, especially for people with limited mobility. Positioning the CULTA LED is very easy. The large illumination field has a pleasant light colour and provides ideal light for reading and relaxing.



CULTA LED	technical data
luminous power *	1,100 Lux @ 0.5 m
colour temperature *	3000 K
lighting field @ 0.5 m *	Ø 60 cm
colour rendering index	Ra > 80
usage	rocker switch (I/O) on cord
class of protection	II
protection rating	IP 20

special features	
CULTA LED	lampshade white
mounting	<ul style="list-style-type: none"> <li>• pin universal</li> </ul>
accessories	<ul style="list-style-type: none"> <li>• fasting hardware</li> <li>• wall mount</li> <li>• table clamp</li> </ul>

# CULTA LED – variations



CULTA LED S4 P 23

pin version



CULTA LED S4 B S9

universal bed adapter



**Practical and durable**

The flexible gooseneck and the rotatable head of the CULTA LED bedside reading lamp ensure that the light can be directed easily and precisely. The large light field has a pleasant light colour and provides comfortable light for reading.

**Universally applicable**

In residents' and patients' rooms, the CULTA LED can be used universally on rails, tables or walls. The CULTA LED S 4 B S9 version can be mounted directly on the bed with optional connection to a bed motor control.

Product highlights



**Hygiene**  
simple and closed construction facilitates cleaning

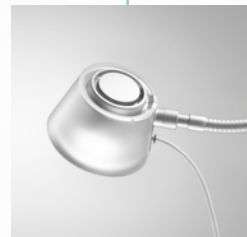

**Elegant design**  
transparent lampshade appears noble and harmonizes with any furnishing style

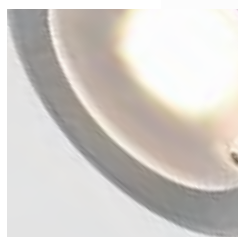

**Retrofit illuminant**  
replaceable

**Intuitive operation**  
thanks to cord switch, even with limited ability to move

# Laboratory luminaires



## Light at the workplace

Optimal working conditions are created by light that adapts to personal requirements. Excellent colour rendering properties of light are indispensable to obtain optimal working conditions. TANEО Lab luminaires meet the special needs of technicians e. g. dental technicians.

### TANEО Lab



[www.derungs.swiss](http://www.derungs.swiss)  
Further variants and technical  
notes can be found here.

# TANEO Lab



## Colour determination in daylight quality. TANEO Lab

The TANEO Lab is an all-round talent with optimal light. The high quality of light and ergonomic handling are ideal for dental laboratories. TANEO Lab offers individual adjustment possibilities with its uniquely movable and balanced arm with a large radius of action. Thanks to the first-class colour rendering properties, contrasts and colours are optimally displayed.



TANEO Lab	technical data **
luminous power *	1,400-2,000 lm
colour temperature *	5000 K / 3000-6500 K Tunable White / full spectrum D50
colour rendering index	Ra > 90
usage	membrane switch
class of protection	II
protection rating	IP 20

special features	
TANEO Lab 23-5 000 TANEO Lab 30-5 000	<ul style="list-style-type: none"> <li>• high colour rendering property</li> <li>• withdrawal protection</li> </ul>
TANEO Lab 30-Tunable White	Tunable White: adjustable colour temperature 3000-6500 K
TANEO Lab 38-D50	full spectrum, Ra > 95, R9 > 85
mounting	pin universal <ul style="list-style-type: none"> <li>• table clamp</li> <li>• universal mount</li> </ul>
accessories	<ul style="list-style-type: none"> <li>• extension arm with removal protection</li> <li>• wall mount</li> </ul>

# TANEO Lab – variations



## TANEO Lab

23-5000: width 398 mm



## TANEO Lab

30-5000 / 30-tunable white / 38-D50: width 577 mm



## Product highlights



**Intuitive operation**  
switch in the luminaire head for on / off and dimming



**Reliable positioning**  
spring arm with 3D head joint for stable alignment of the illumination field



**High quality**  
white housing made of anodised aluminium and black plastic

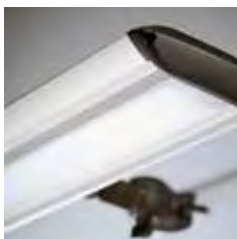

**Different colour temperatures**  
version with full spectrum D50, Tunable White or 5000 K available

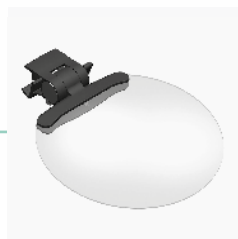

**Additional magnifying lens**  
easy to install thanks to a clip, 3.5 dioptres (approx. 1.9x magnification), lens diameter 132 mm

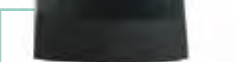

**Universal connection**  
by means of included screw-on flange, extensive accessories available for mounting by means of table clamp, universal mounting, wall bracket or extension arm



**AGR certified**  
ergonomically optimised for gentle work in an upright, back-friendly posture

# Accessories





# ACCESSORIES



## Handle

for TRIANGO 130 / 100 / 60, sterilizable



## Handle

for TRIANGO 80, sterilizable



## Disposable sterile cover

for all TRIANGO handles



## Extension arm

- for VISIANO 20, VISIANO 10, HALUX N50 / N30, OPTICLUX 10
- for luminaires with 16 mm pin attachment



## Tubular Mount

for round and oval profiles  
ø 30 mm to 40 mm



# ACCESSORIES



for luminaires with 16 mm pin attachment

## Table clamp

for VISIANO 20, VISIANO 10,  
HALUX N50 / N30, OPTICLUX, AMALIA



## Universal mount

for VISIANO 20, VISIANO 10,  
HALUX N50 / N30, OPTICLUX, AMALIA

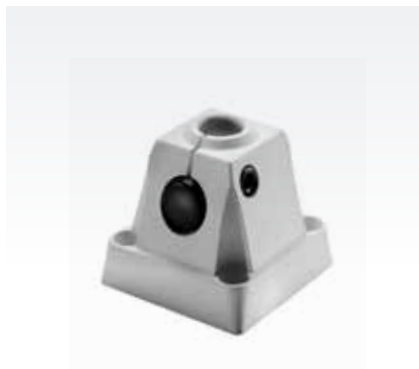

## Rail mount

for VISIANO 20, VISIANO 10,  
HALUX N50 / N30, OPTICLUX, AMALIA



## Wall mount

for VISIANO 20, VISIANO 10,  
HALUX N50 / N30, OPTICLUX, AMALIA



## Wall mount - ALU

for VISIANO 20, VISIANO 10,  
HALUX N50 / N30, OPTICLUX, AMALIA



## Bedside adapter

- extension adapter
- for spigot Ø 16 mm with pull-out protection



# ACCESSORIES



## Aluminium rail

- 25 x 10 mm
- for VISIANO 20, VISIANO 10, HALUX N50 / N30, OPTICLUX, AMALIA



## Roller stand

- for VISIANO 20, VISIANO 10, HALUX N50 / N30, OPTICLUX
- for luminaires with 16 mm pin attachment



## Intermediate ceiling adapter

for TRIANGO 130, TRIANGO 100, TRIANGO 80, VISIANO 20, OPTICLUX 10



## Rail mount gynecology chair

- for HALUX N50 / N30
- connection to gynecology chair
- for lights with 16 mm pin fastening with removal protection and brake function



AMALIA  
decor white



AMALIA  
decor flower



AMALIA  
decor Rattan



Table charging station  
for Opticlux Hand



Additional magnifier  
for TANEQ Lab



Cover plate  
100 mm / 385 mm



# Support arm systems





# TENO



## Many applications. High load capacity. One arm. TENO

The premium support arm system for medical applications. The spring arm is individually adjustable. Flat screens, patient multimedia systems and medical lights can be mounted almost independent of the payload. The high-quality aluminum arm system ensures good cleaning properties and a long service life.

TENO	technical data
load capacity	max. 30 Nm
vertical angle of movement	+45° up / -65° down
joint relief	spring assembly
weight (net)	ca. 17.5 kg

special features	
TENO	<ul style="list-style-type: none"> <li>• can be positioned with little force</li> <li>• high positional accuracy</li> <li>• application specific load adjustment of up to 30 nm</li> <li>• easy mounting</li> </ul>
fastening	<ul style="list-style-type: none"> <li>• ceiling</li> <li>• pin</li> <li>• roller stand</li> </ul>

# TENO C Duo



# TENO - variations



TENO C Duo  
Duo system



TENO C  
ceiling version



TENO W  
wall version



TENO F  
roller stand



# VISO



## Reliable and solid. VISO

VISO is a proven support arm system with an integrated converter.

At the same time, the aluminium arm and spring-relieved friction joints ensure effortless and safe positioning. VISO is designed for rather light loads.

TENO	technical data
load capacity	max. 10 Nm
joint relief	spring assembly and friction discs
weight (net)	ca. 1.4 kg

special features
<p><b>VISO</b></p> <ul style="list-style-type: none"> <li>• easy to position</li> <li>• multiple spring-relieved</li> <li>• application specific load design up to 10 nm</li> <li>• easy mounting</li> <li>• individual mounting adapter</li> </ul>
<p><b>fastening</b></p> <ul style="list-style-type: none"> <li>• ceiling</li> <li>• pin</li> <li>• roller stand</li> </ul>

# VISO – variations



VISO C  
ceiling version | on request



VISO P  
pin version | on request



VISO P with roller stand  
in combination | on request



# Service





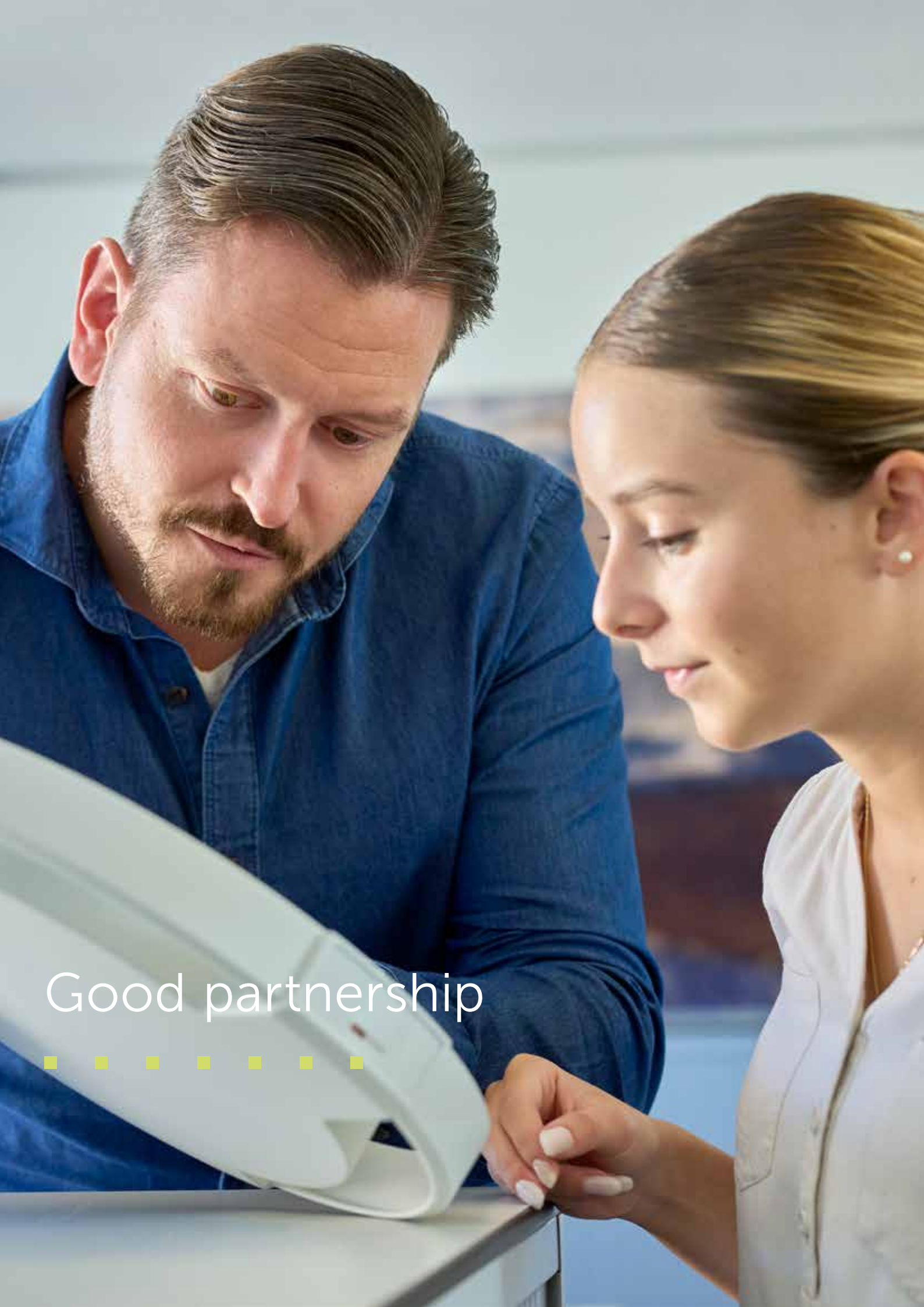

Good partnership



## Service and support

We not only want to develop the optimal products for you, we also want to be the best partner. That is why we are happy to support you in all phases of your project, in all questions concerning planning, installation and use of our products.

### Product consultation & sampling

Derungs medical luminaires cover a wide range of applications in human and veterinary medicine. Discover the advantages of Derungs luminaires in a conversation or as part of a sampling. Let us inspire you.

### Technical service

We answer your questions about technology, installation and care of your Derungs-quality luminaire. If you should need repairs or spare parts, our international service network is at your disposal.

### Training

The operation of our luminaires is generally intuitive. So that our users can benefit from the best possible working conditions, we make our dealers, facility managers and service technicians fit for Derungs.

### Downloads

On our website you will always find the latest information. Our specialist dealers receive exclusive access to marketing and sales documents. Contact your sales consultants for more information.

### Logistics & order

If you would like to know more about your desired luminaire or would like a quotation, your specialist dealer or one of our advisors will be happy to answer your questions.



[derungs.swiss/contact](https://derungs.swiss/contact)

**5** YEARS  
WARRANTY  
for all electrical  
components



# Register products



## Would you like a little more?

Medical luminaires from Derungs stand for highest quality, optimal light output and high-class design. In addition, you can now register your Derungs medical and enjoy further advantages.

Register your Derungs medical light and benefit:

### **Plus 1 year warranty**

The warranty is extended automatically upon completion of registration to a total of 3 years (for mechanical parts).

### **Current information according to MDR**

For product updates and recalls you will be informed immediately.

### **In 3 simple steps:**

- scan QR Code
- fill out online form
- done!

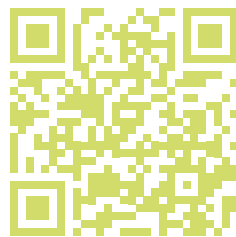

**Derungs.swiss/  
product-registration**

# Light Facts





# Colour temperature and colour rendering



## Two decisive quality features

In medical technology, colour temperature and colour rendering properties are important quality characteristics for evaluating a luminaire. They describe how well colours are reproduced in the work or examination area under artificial light.

### Colour temperature of light:

The colour temperature describes the colour impression of an illuminated object. This depends on the spectral composition of the light and is given in the unit Kelvin.

The following applies: The higher the temperature value, the cooler white the light colour.

#### Warm white: 2500 to 3300 K

emphasizes red, yellow and orange tones –  
cozy light for comfortable rooms

#### Neutral or universal white: 3300 to 5300 K

contrasts are emphasized –  
concentration enhancing, working light

#### Daylight white or cool white: > 5300 K

emphasizes blue, purple and green tones –  
attention-grabbing and activating



### Colour rendering index

The colour rendering index Ra (Colour Rendering Index, CRI) is used to evaluate artificial light sources. This index indicates how true to nature the colours are under the light source in question compared to the colour rendering under natural daylight.

The highest value of Ra is marked with the number 100. Ra 100 means that all colours of an object are recognized as they would be under daylight: These therefore appear to the observer as "natural". The more the colour rendering index Ra deviates from 100, the worse the colours on illuminated objects are reproduced.

### How is the Ra value determined?

In order to determine the Ra value of a light source usually 8 frequently occurring test colours are used with a reference light source and the light source to be tested. The smaller the deviations between the reference light source and the light source under test, the better the colour rendering property of the light source under test.

- Test colour R9 particularly important for differentiating various shades of red in tissue and blood
- Test colour R13 is the "skin colour", important to better identify veins and blood vessels

Ra 65

Ra 73

Ra 95



# Colour temperature - the test





# Wood's Light



## Dermatological diagnoses in human, legal and veterinary medicine.

Lights with Wood's Light or black light are special examination lights. They are used for the diagnosis of skin and scalp lesions. In the process, disease lesions and pigmentary changes fluoresce under UV light.

### Example areas of application:

#### suspicious lesions of the skin

Illuminating the skin with ultraviolet light causes a fluorescent glow of some bacteria and fungi.

Wood's Light also highlights skin pigments.

Pigmentary disorders, such as vitiligo or dermatomycosis, can be diagnosed more easily.

#### Vitiligo in light skin types

Wood's Light can be used for the early diagnosis of vitiligo. Especially in patients with light skin, lesions can be detected early and thus be treated more quickly. These areas have sharper boundaries under Wood's Light and look light blue-white or yellow-green.

Other vitiligo-like conditions:

- ESCHENLAUBFLECKEN (M. Pringle)
- (blue-white fluorescence compared to normal skin)

#### Pseudomonas - bacterial infections

Inflamed wounds of the skin should be examined by the trained eye of a physician, because infections caused by bacteria such as Pseudomonas can lead to serious complications, especially in burns.

If Wood's Light is used for the examination the bacteria look bright green.

Other bacterial skin diseases

- ERYTHRASMA (red fluorescence)

#### Tinea capitis - shear fungal lichen

Round, bald or scaly areas on the scalp or in the beard indicate a tinea infection. For the visual diagnosis of tinea capitis, Wood's Light examination lights can be used. The fungal species that cause tinea capitis, look blue-green or dull blue under Wood's Light.

Other dermatomycoses:

- FAVUS (toxic green fluorescence)
- TRICHOBACTERIOSIS AXILLARIS (yellow-ochre fluorescence)
- MICROSPORIA (faint greenish fluorescence)
- PITYRIASIS VERSICOLOR (yellow-ochre fluorescence)

#### Head lice or hair spray residue?

The causes of itchy scalp can be many and varied. Head lice are one possible diagnosis. However, nits from head lice are difficult to distinguish from dried hair spray or bandages from hair.

If one uses a Wood's Light lamp for examination, nits can be unmasked relatively quickly. Live nits glow white under a Wood's Light, while empty nit containers look gray.

Another parasitic infectious disease:

- SKABIES (gray-white mite ducts)

### Our OPTICLUX magnifier lamps with Wood's Light

This special model variant combines two illumination modes in one unit: daylight white illumination and Wood's Light. Thus, different examinations can be performed with only one light. Conventional Wood's Light require a complete darkening of the room. Thanks to highly efficient LEDs, this is not necessary with the Opticlux.



And that means less effort and more time for the patients.

#### LED light and dimming

Skin with LED light similar to daylight.

#### Wood's Light (365 nm)

reliable diagnosis: skin lesions appear different with Wood's Light, e.g. in skin diseases such as favus, intertrigo types, erythrasma.



# Real passion for medical lighting



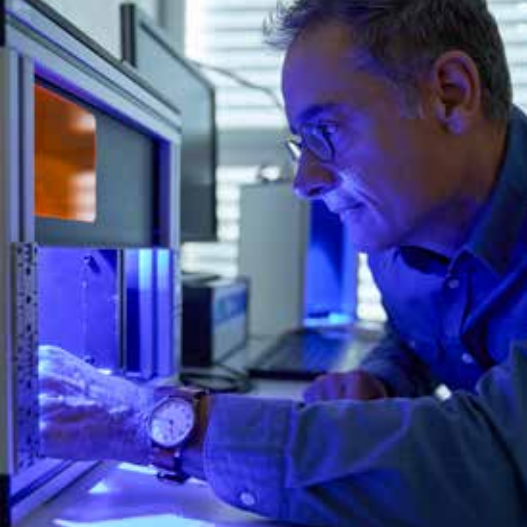

We are a modern, reliable and innovative company where people work whose hearts beat for medical technology.

In Switzerland, we develop and assemble high-quality lighting solutions for medical applications.



**We are networkers**



**Quality management**



**Our awards**



**reddot winner**

**Our value proposition**



**List of sources**

Stock images:

shutterstock.com:

- 10 @ hxdbzxy
- 10 @ Gorodenkoff
- 10 @ L Julia
- 10 @ Kichigin
- 10 @ everything possible
- 10 @ Anna Hoychuk
- 67 @ stockfour

123rf.com:

- 107 @ wavebreakmediamicro
- 108 @ profile\_visualism

All other photos and graphics are intellectual property of Derungs Licht AG





## Headquarters

Derungs Licht AG  
Hofmattstrasse 12  
9200 Gossau  
Switzerland  
+41 71 388 11 66  
mailbox@derungs.swiss  
www.derungs.swiss

## Consulting & Distribution

### Germany

Derungs Medical GmbH  
Rudolf-Diesel-Strasse 2  
78239 Rielasingen-Worblingen  
Germany  
+49 7731 90 97 19-0  
info@derungsmedical.com

### France

Waldmann Eclairage S.A.S.  
Zone Industrielle  
Rue de l'Embranchement  
67116 Reichstett  
France  
Phone +33 3 88 20 95 88  
Fax +33 3 88 20 95 68  
info-fr@waldmann.com

### Italy

Waldmann Illuminotecnica S.r.l.  
Via della Pace, 18 A  
20098 San Giuliano Milanese (MI)  
Italy  
Phone +39 02 98 24 90 24  
Fax +39 02 98 24 63 78  
info-it@waldmann.com

### Netherlands

Waldmann BV  
Lingewei 19  
4004 Lk Tiel  
Netherlands  
Phone +31 344 631019  
Fax +31 344 627856  
info-nl@waldmann.com

### Austria

Waldmann Lichttechnik Ges.m.b.H.  
Gewerbepark Wagram 7  
4061 Pasching/Linz  
Austria  
Phone +43 7229 67400  
Fax +43 7229 67444  
info-at@waldmann.com

### Scandinavia

Waldmann Ljusteknik AB  
Botvid Business Center  
Fågelviksvägen 9  
SE-145 53 Norsborg  
Sweden  
Phone +46 8 990 350  
Fax +46 8 991 609  
info-se@waldmann.com

### Switzerland

Waldmann Lichttechnik GmbH  
Benkenstrasse 57  
5024 Küttigen  
Switzerland  
Phone +41 62 839 1212  
Fax +41 62 839 1299  
info-ch@waldmann.com

### USA

Waldmann Lighting Company  
9 W. Century Drive  
Wheeling, Illinois 60090  
USA  
Phone +1 847 520 1060  
Fax +1 847 520 1730  
waldmann@waldmannlighting.com

### China

Waldmann Lighting (Shanghai) Co., Ltd.  
Part A11a, No. Five Normative Workshop  
199 Changjian Road, Baoshan  
Shanghai, P.R.C. 200949  
China  
Phone +86 21 5169 1799  
Fax +86 21 3385 0032  
info-cn@waldmann.com



Derungs Licht AG is a company of the Waldmann Group

[www.derungs.swiss](http://www.derungs.swiss)